

# NF3000A-YXS Series (RoHS 対応品)

三相3線式 250VAC

省スペースブック型



Type Approved  
Safety  
Regular Production  
Surveillance  
[www.tuv.com](http://www.tuv.com)  
ID 2000000000

UL1283 (file No.E102708)  
EN60939-2 (file No.R50031314)

## 用途

半導体製造装置、工作機械、汎用インバータ、サーボ等の応用装置、CVCF等の電源装置、エレベータ電源、工場電源など

## 仕様

Part No.	Rated Current	Weight	Dimensions [mm]												
			A	B	C	D	E	F	G	H	J	K	L	M	
NF3010A-YXS	10A	0.5kg	110	100	50	40	95	M4	M4	M4	R2.25x6	dia.4.5	9	11	fig1
NF3020A-YXS	20A														
NF3030A-YXS	30A														
NF3040A-YXS	40A	0.8kg	128	120	65	55	95	M5	M5	M4	R2.25x6	dia.4.5	13	16	
NF3050A-YXS	50A														
NF3060A-YXS	60A														
NF3080A-YXS	80A	1.6kg	fig2												
NF3100A-YXS	100A														
NF3125A-YXS	125A	2.8kg	fig3												
NF3150A-YXS	150A														
NF3200A-YXS	200A	6.9kg	fig4												
NF3250A-YXS	250A														
NF3300A-YXS	300A	8.1kg	fig4												
Rated Voltage	250VAC max														
Leakage Current	1.5mA max 200VAC 60Hz By UL1283														
Ambient temp.	-20 up to 50 Deg.C														

fig.1 (10A~60A)

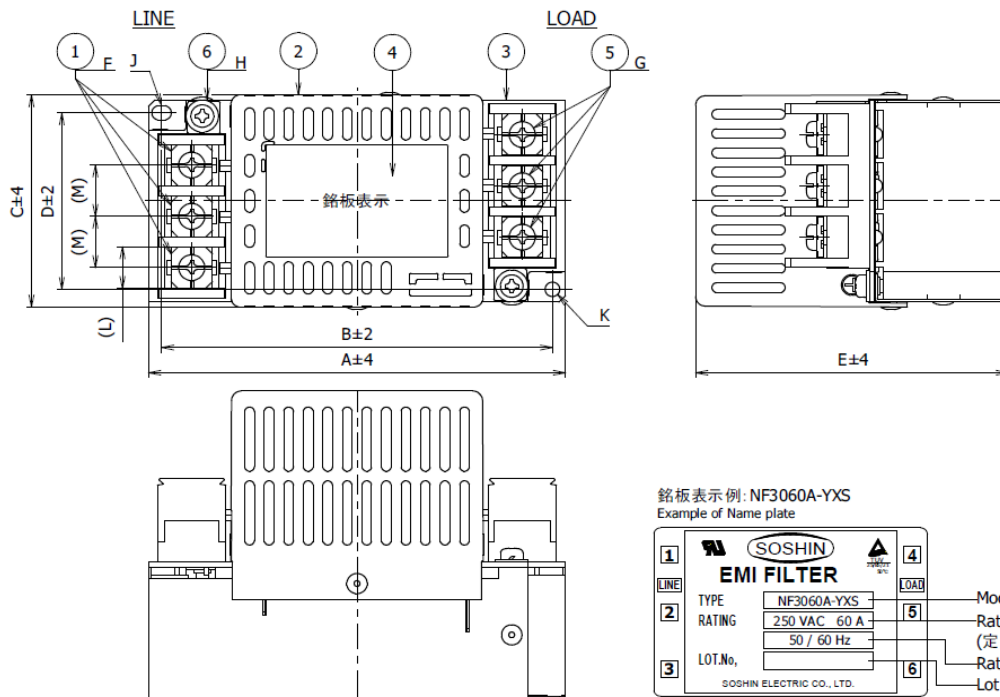

fig.2 (80A, 100A)

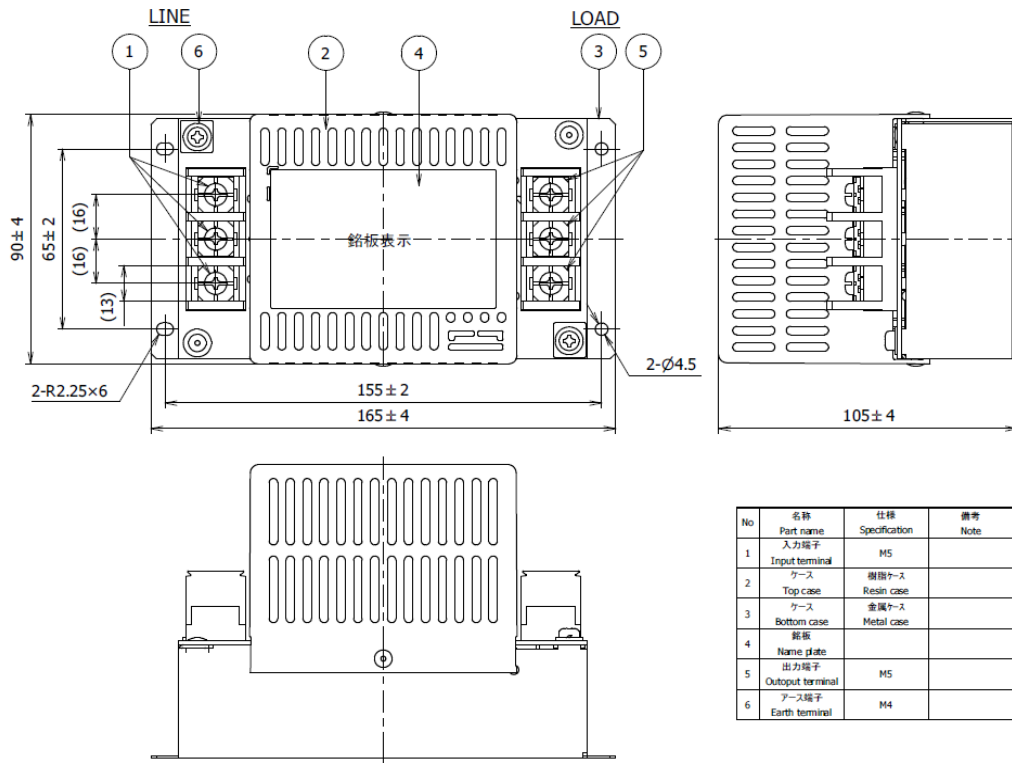

fig. 3 (125A, 150A)

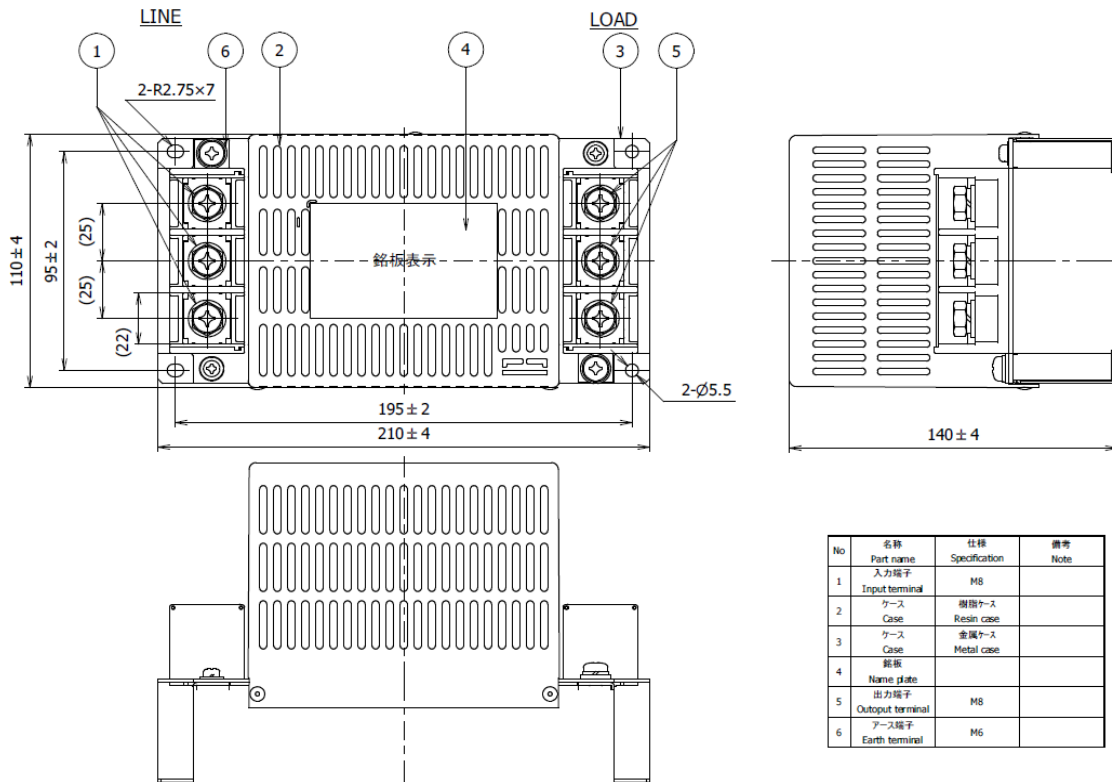
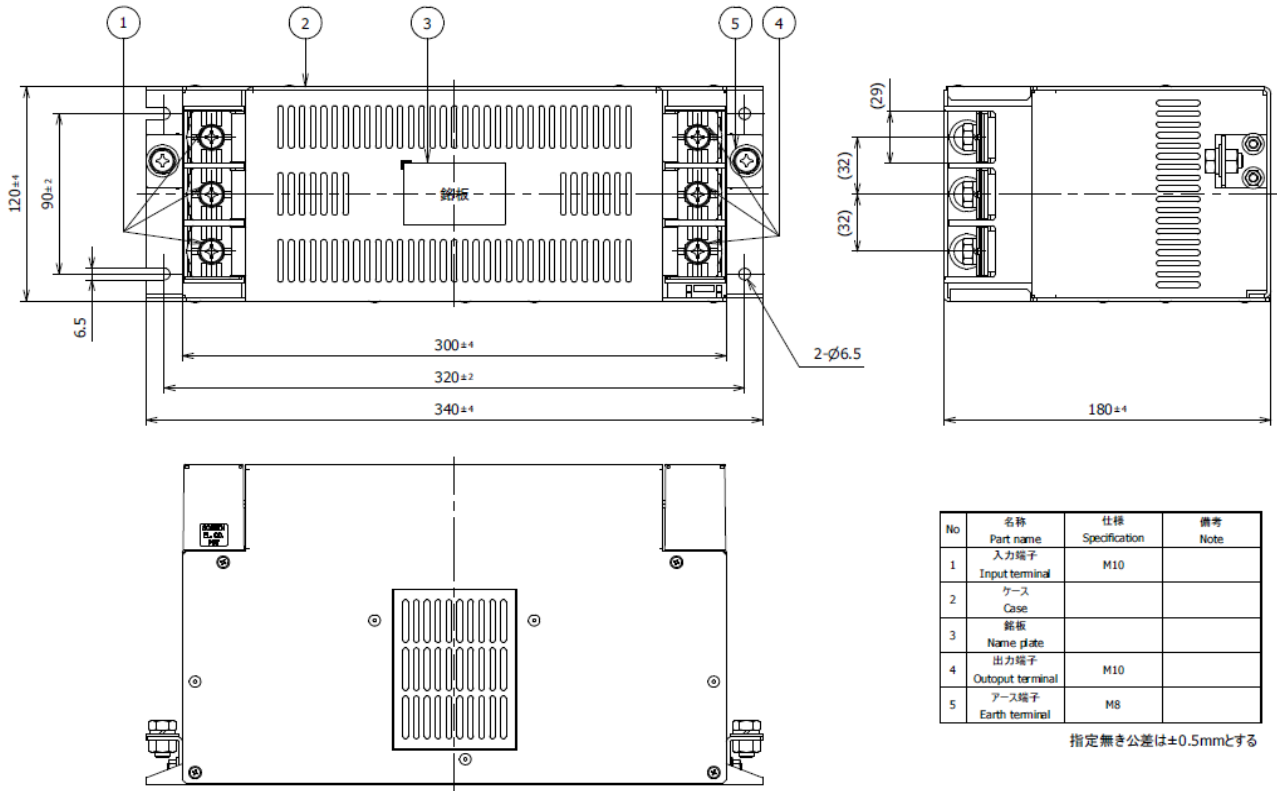
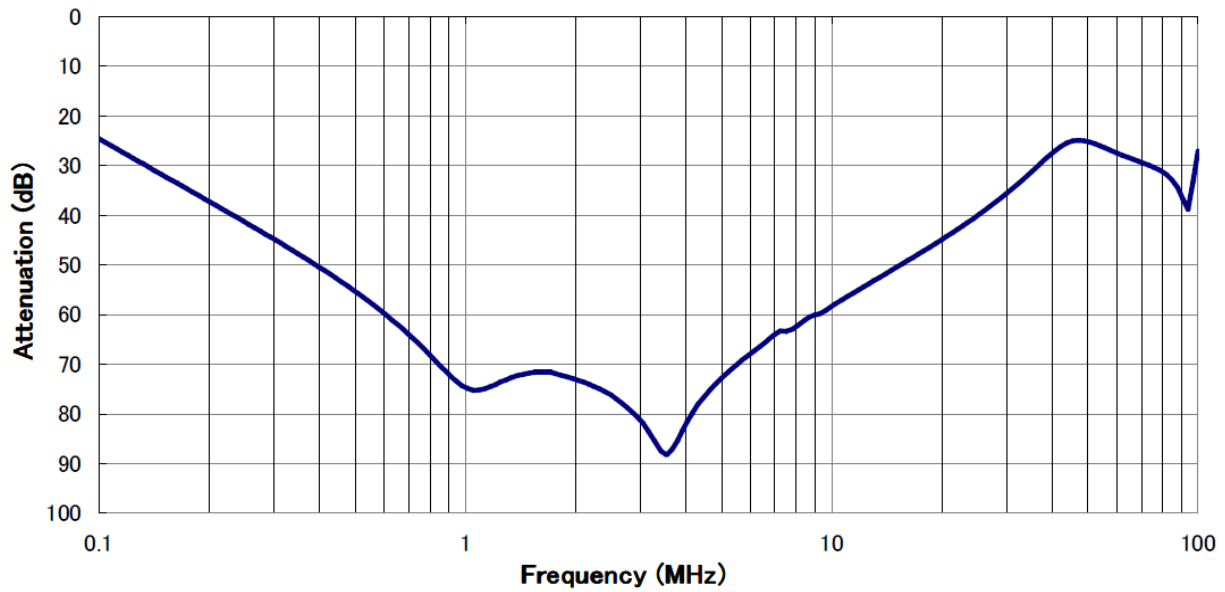

fig. 4 (200A~300A)



代表特性 (10A, 20A, 30A)



代表特性 (40A, 50A, 60A)

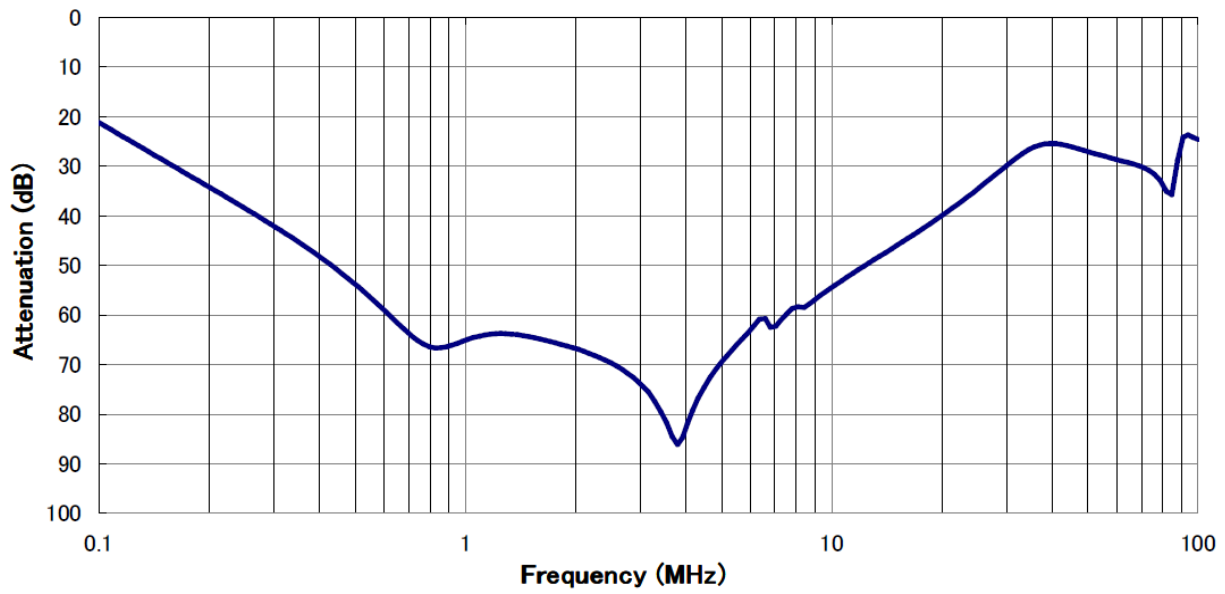

代表特性 (80A, 100A)

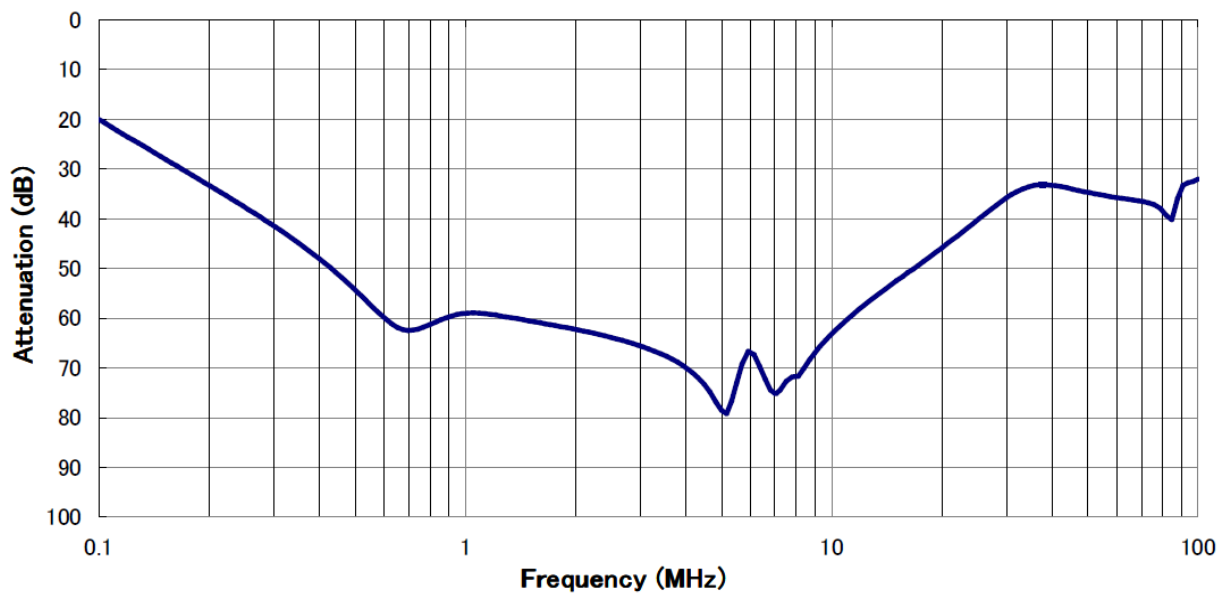

# 代表特性 (125A, 150A)

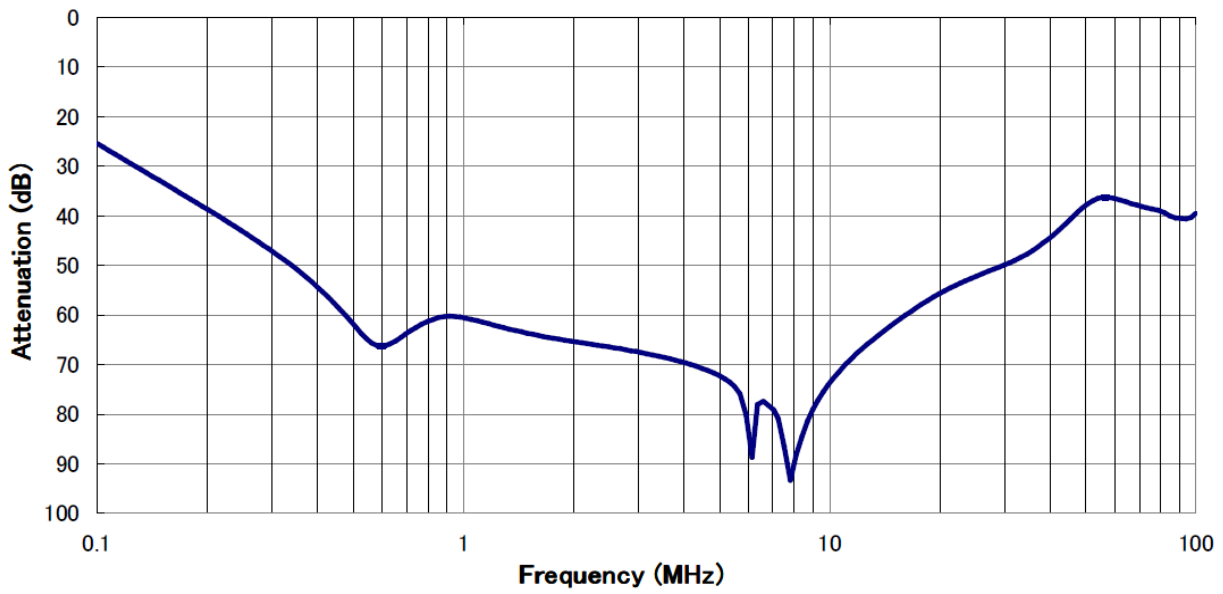

# 回路図

