

NF3000C-UQA Series (RoHS 対応品)

三相3線式 480VAC

大電流・省スペース(低漏洩電流タイプ)



400A品 外観



UL1283 (file No.E102708)

EN60939-2 (file No.R50031225)

SCCR対応(200~400A品)

・ブレーカとコンビネーションで取得

・Listed認定品であればどのメーカーのブレーカでも使用可能

用途

IGBTインバータ、ACサーボ、NC制御機器など

仕様

Part No.	Rated Current	SCCR value	Weight	
NF3200C-UQA	200A	30kA	10Kg	fig1
NF3250C-UQA	250A		11Kg	
NF3300C-UQA	300A		12Kg	
NF3400C-UQA	400A	-	20Kg	fig2
NF3500C-UQA	500A		26Kg	fig3
NF3600C-UQA	600A		38Kg	fig4
NF3700C-UQA	700A			
NF3800C-UQA	800A			
NF3900C-UQA	900A	60Kg	fig5	
NF31000C-UQA	1000A			
Rated Voltage	480VAC max			
Leakage Current	10mA max/400VAC 50Hz By UL1283			
Ambient temp.	-20 up to 50 Deg.C			

fig. 1 (200, 250, 300A)

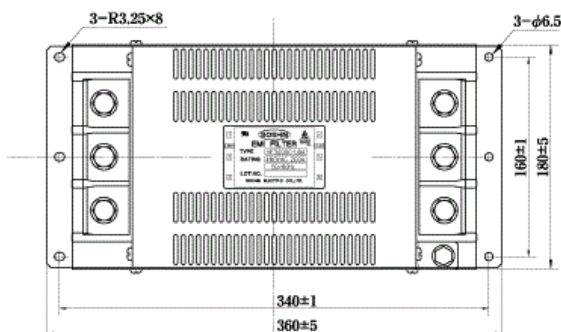

No	Item	Notes
①	Input terminal	M10
②	Metal case	
③	Label	
④	Output terminal	M10
⑤	Earthing terminal	M8

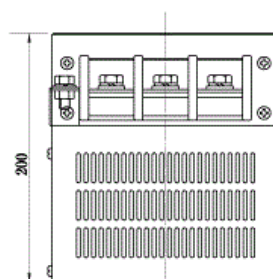
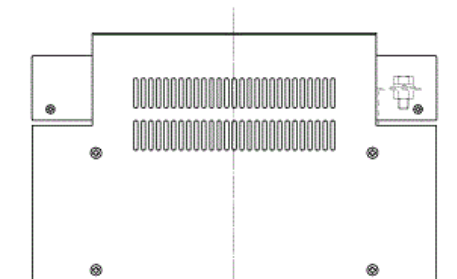
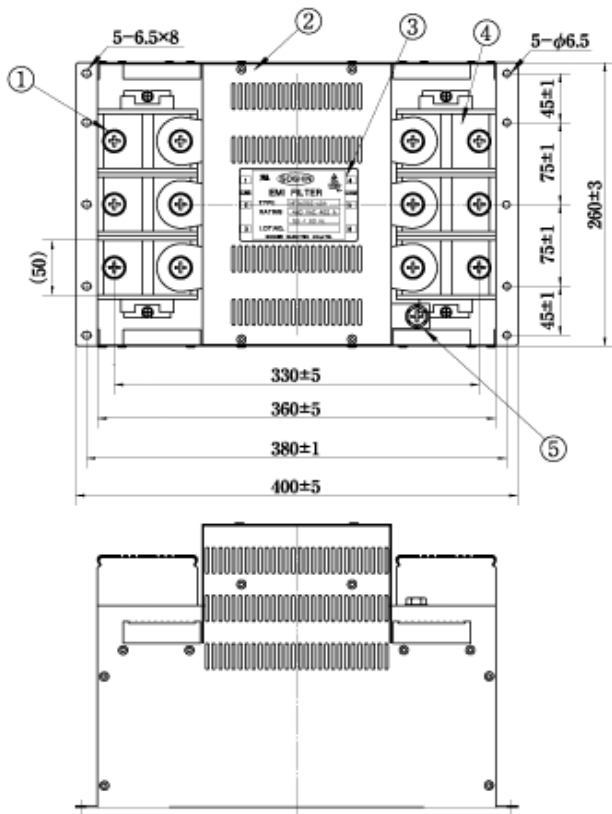

fig. 2 (400A)



No	Item	Notes
①	Input terminal	M12
②	Metal case	
③	Label	
④	Output terminal	M12
⑤	Earthing terminal	M10

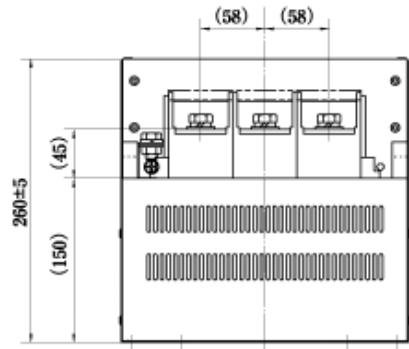
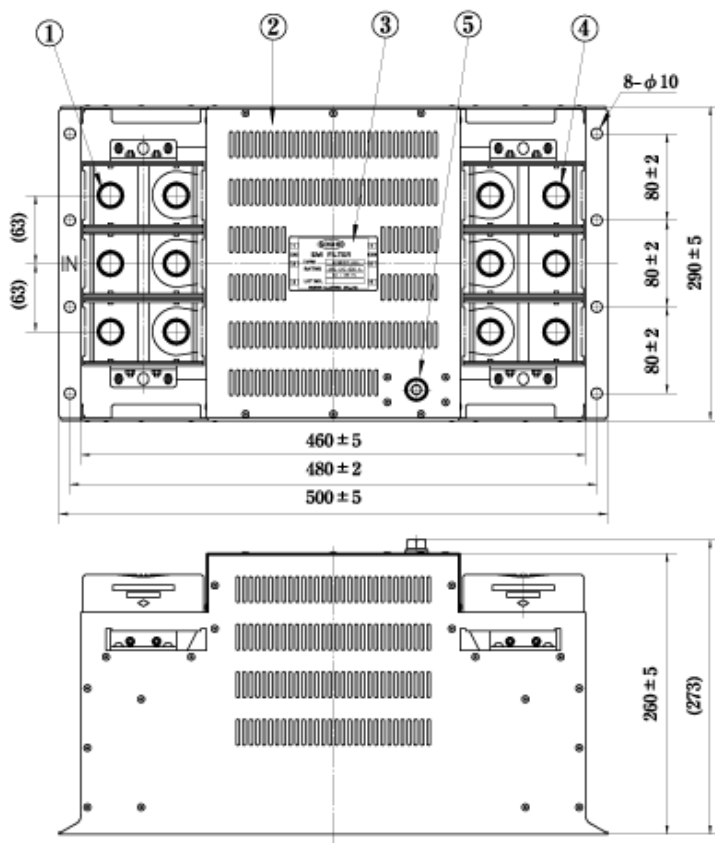

fig. 3 (500, 600A)



No	Item
1	Input terminal (M12)
2	Metal case
3	Label
4	Output terminal (M12)
5	Earthing terminal (M10)

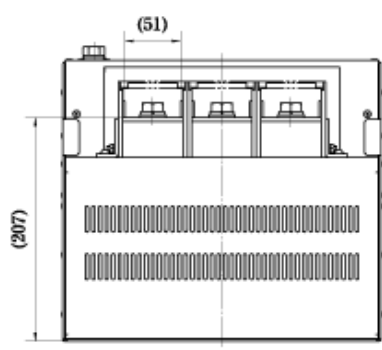

fig. 4 (700, 800A)

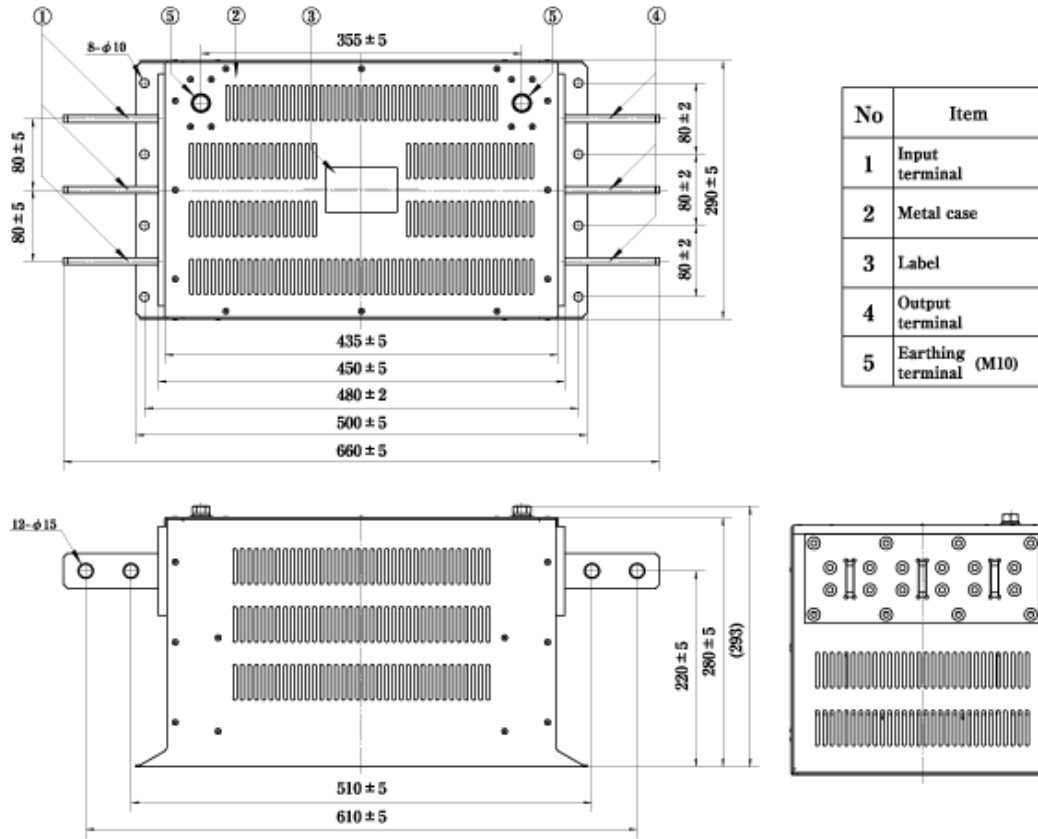
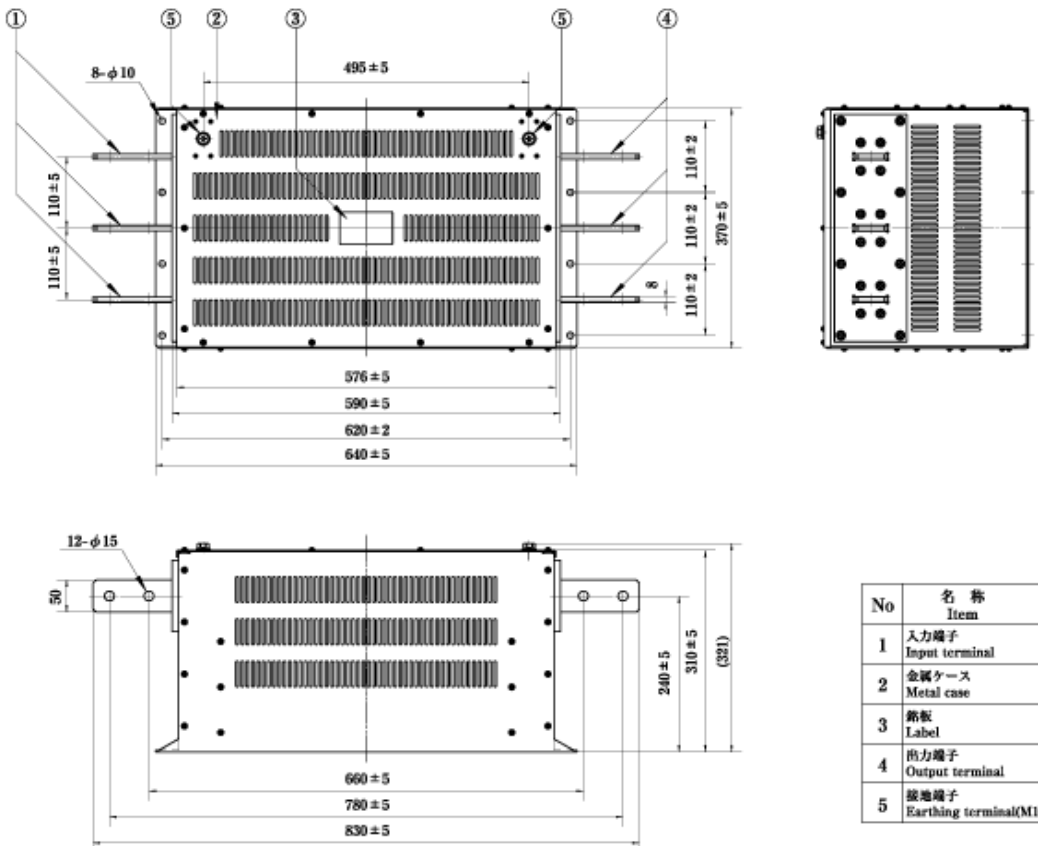
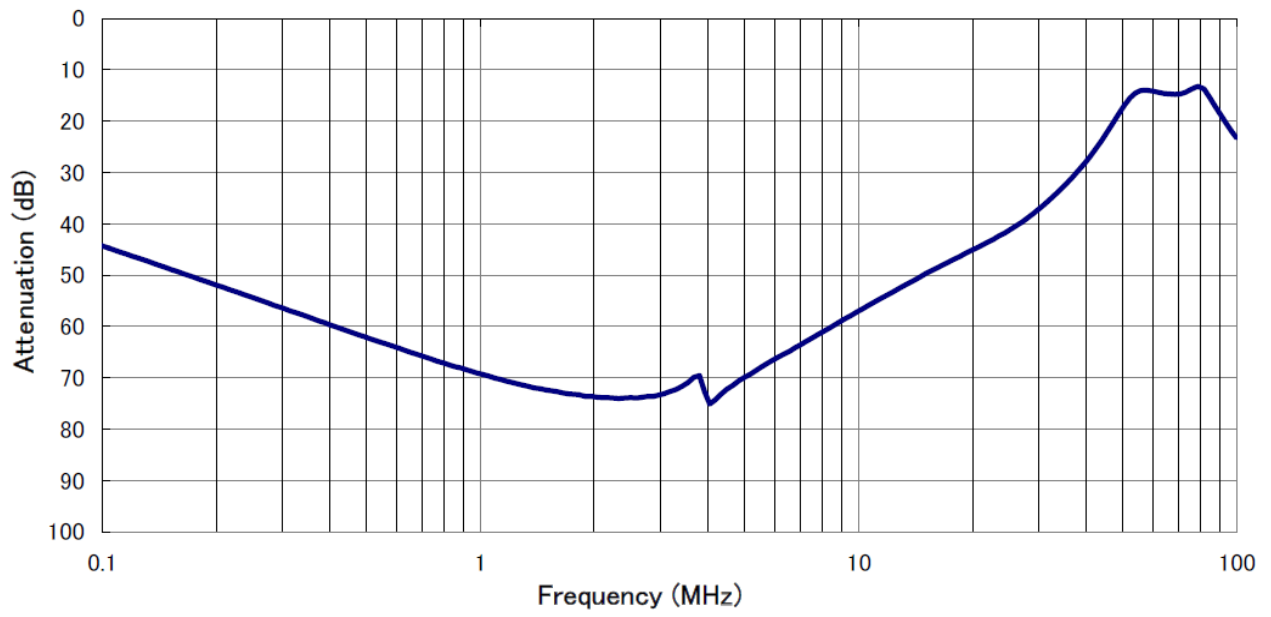

fig. 5 (900, 1000A)



減衰特性 (200A)



減衰特性 (600A)

