

RC500ZZ Series

Ferrite core with metal fitting for installation



Applications

Signal line, switching power supply, inverter etc.

Specifications

Measurement temperature 23+/-2Deg.C							
Type	100KHz(uH)	500KHz(uH)	Dimension(mm)				
			A	B	C	D	
RC5038ZZ	7.29-12.01	>=3.27	42.5	16.5	16	28	fig1
RC5047ZZ	6.86-10.94	>=3.11	51.5	24.5	18	34	
RC5060ZZ	6.02-9.60	>=1.50	fig2				
RC5078ZZ	7.53-12.24	>=1.30	fig3				
RC5096ZZ	4.71-7.66	>=1.30	fig4				
RC5128ZZ	>=5.20	>=1.30	fig5				

Note: Measured by YHP manufactured multi-frequency LCR meter 4284A or equivalent.
Condition for the measurement f=100KHz,500KHz 1T 10mA through.

fig.1

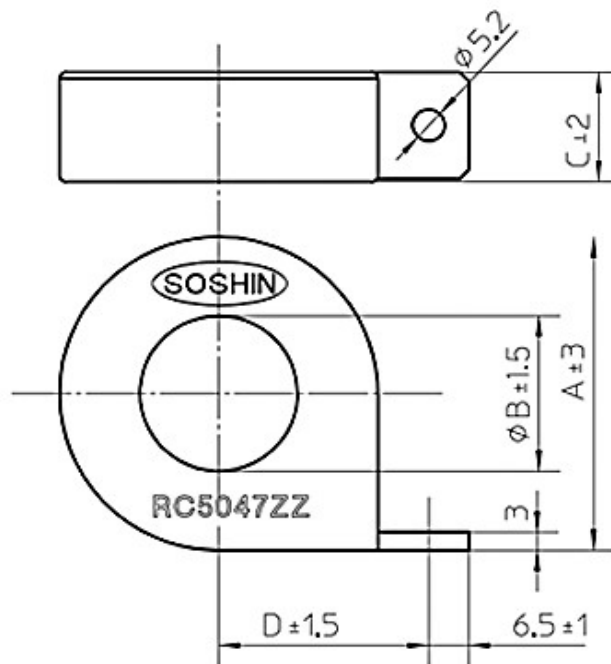

fig.2

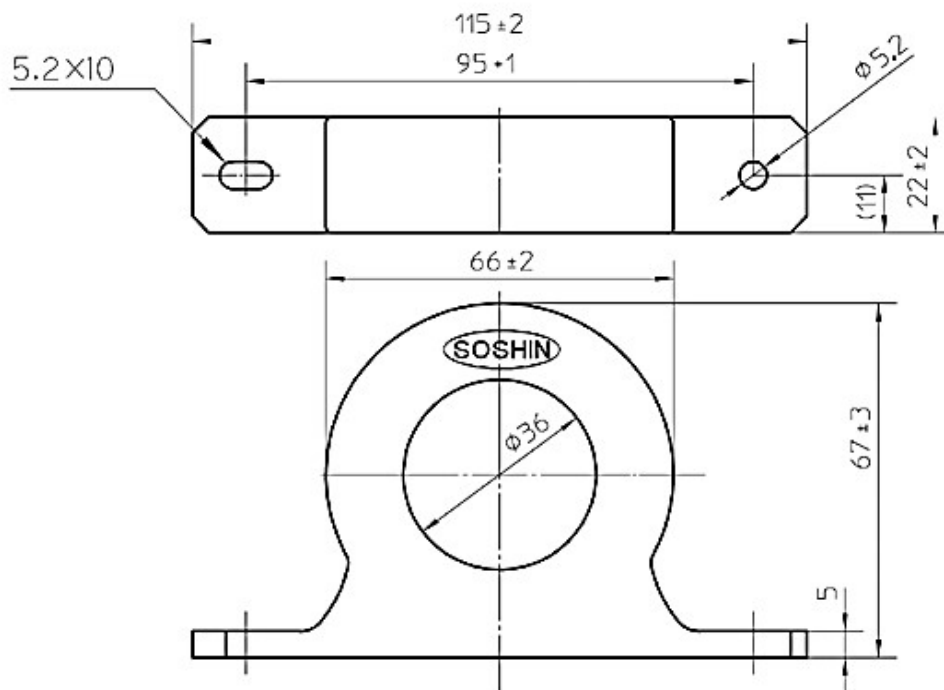
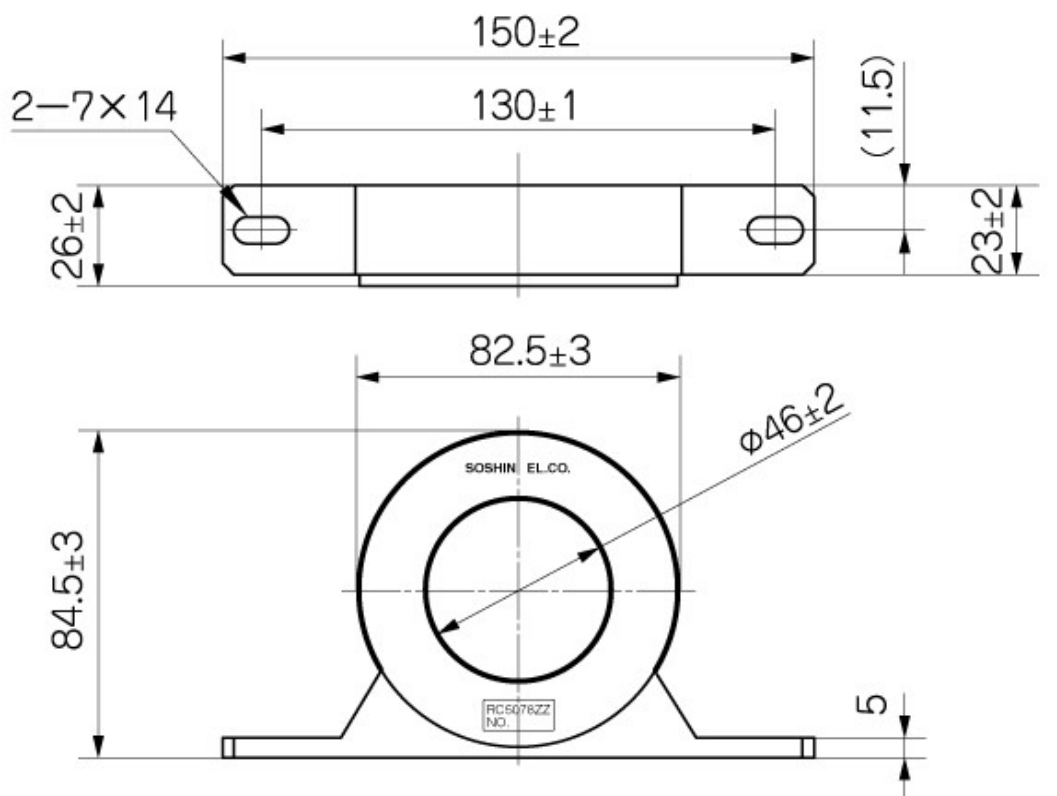

fig.3



指定なき公差は、 ± 2.0

fig.4

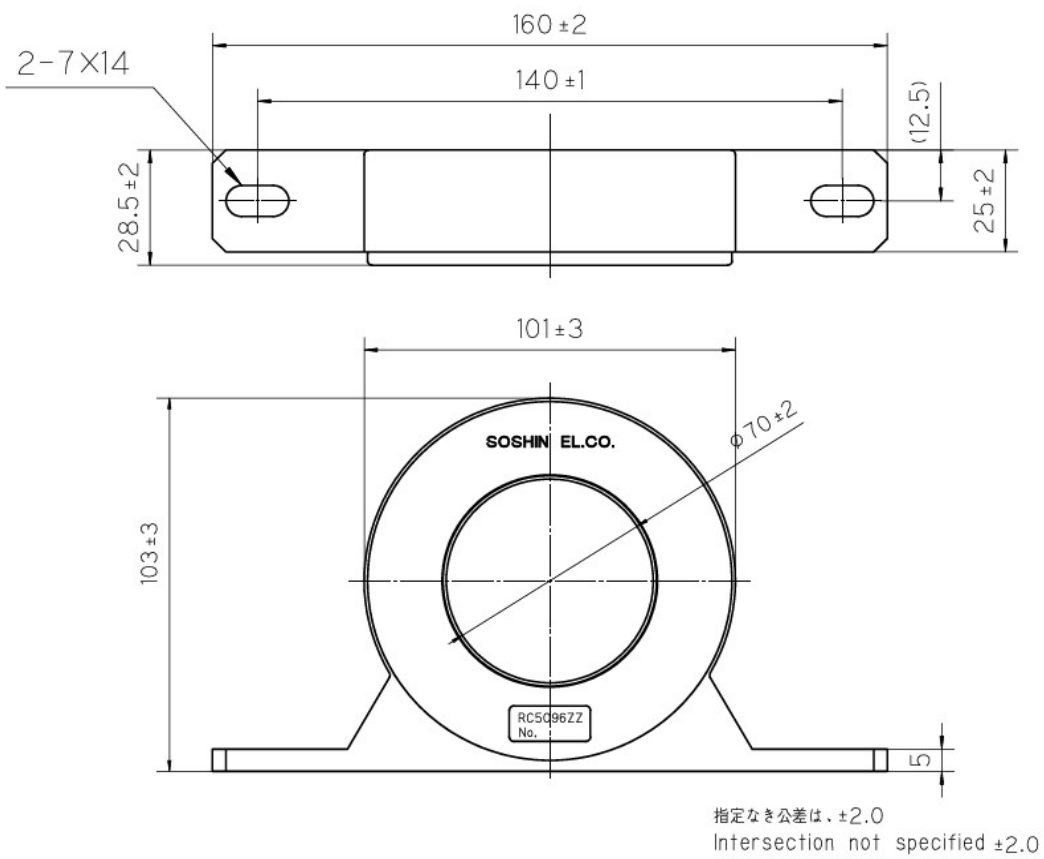

fig.5

