

# HF3000A-UN Series (RoHS认证产品)

三相三线式 250VAC

低频高衰减型, 适用于AC伺服机器



UL 1283 (file NO.E102708)  
EN60939-2 (file No.R50031751)

## 用途

IGBT变频器、AC伺服、NC控制器等

## 规格

Parts No.	Rated Current	Weight	Dimensions [mm]											M	
			A	B	C	D	E	F	G	H	J	K	L		
HF3010A-UN	10A	3.5Kg	300	288	273	258	110	85	32	65	41	M4	M4	5.5X7	fig1
HF3030A-UN	30A	5.5Kg	260	210	85	155	140	125	44	140	70	R3.25 L8	M5	M4	fig2
HF3040A-UN	40A	6Kg													
HF3060A-UN	60A	10Kg	290	240	100	190	175	160	44	230	160	R3.25 L8	M6	M4	
HF3100A-UN	100A	12Kg													fig3
HF3200A-UN	200A	18Kg													fig4
Rated Voltage	250VAC max														
Leakage Current	10A-30A: 5mA max/40A-100A: 6.5mA max/200A: 9mA max 250VAC 60Hz By UL1283														
Ambient temp.	-20 up to 50 Deg.C														

fig.1 (10A)

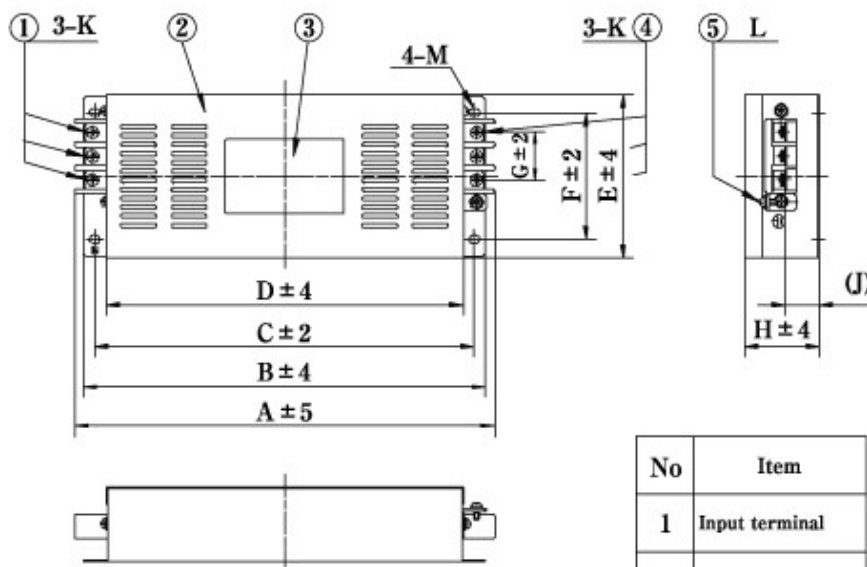

No	Item
1	Input terminal
2	Metal case
3	Label
4	Output terminal
5	Earthing terminal

fig.2 (30, 40, 60A)

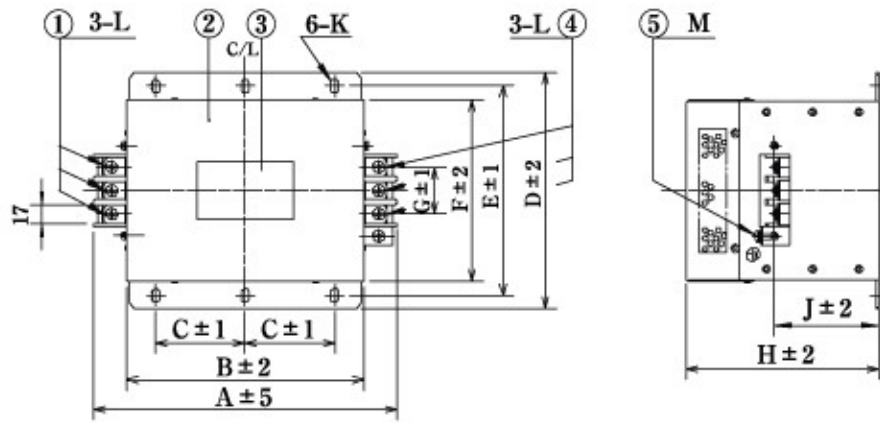

No	Item
1	Input terminal
2	Metal case
3	Label
4	Output terminal
5	Earthing terminal

fig. 3 (100A)

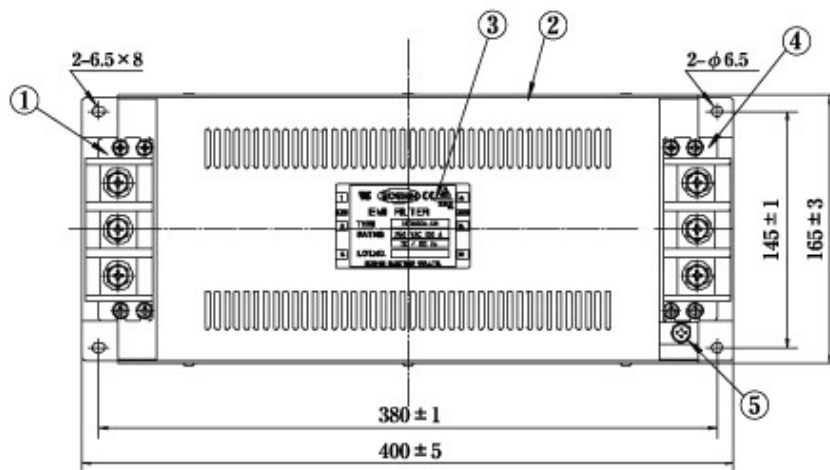

No	Item
1	Input terminal (M8)
2	Metal case
3	Label
4	Output terminal (M8)
5	Earthing terminal (M6)

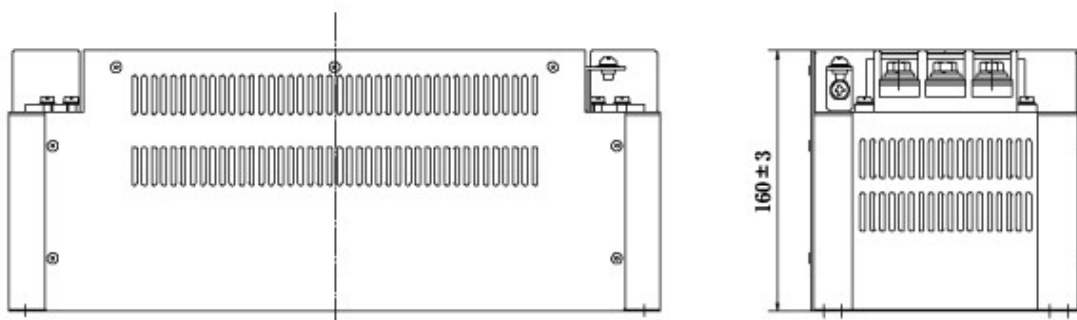
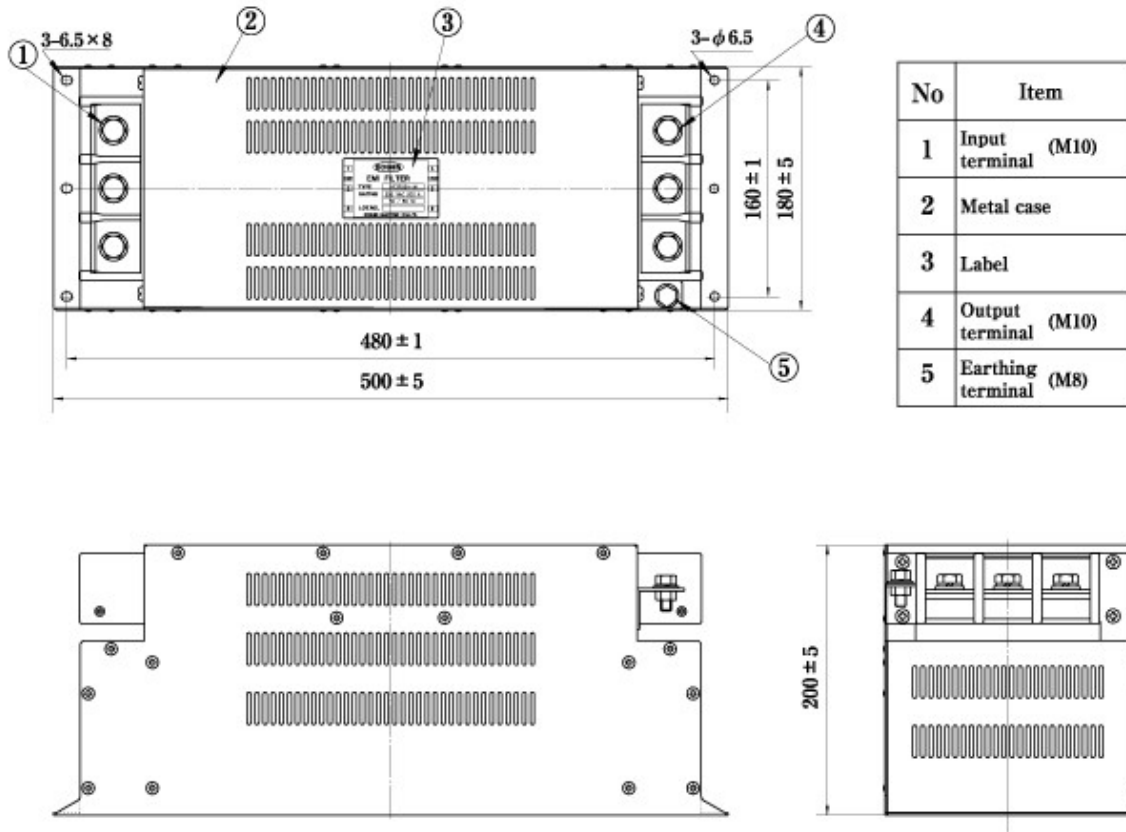
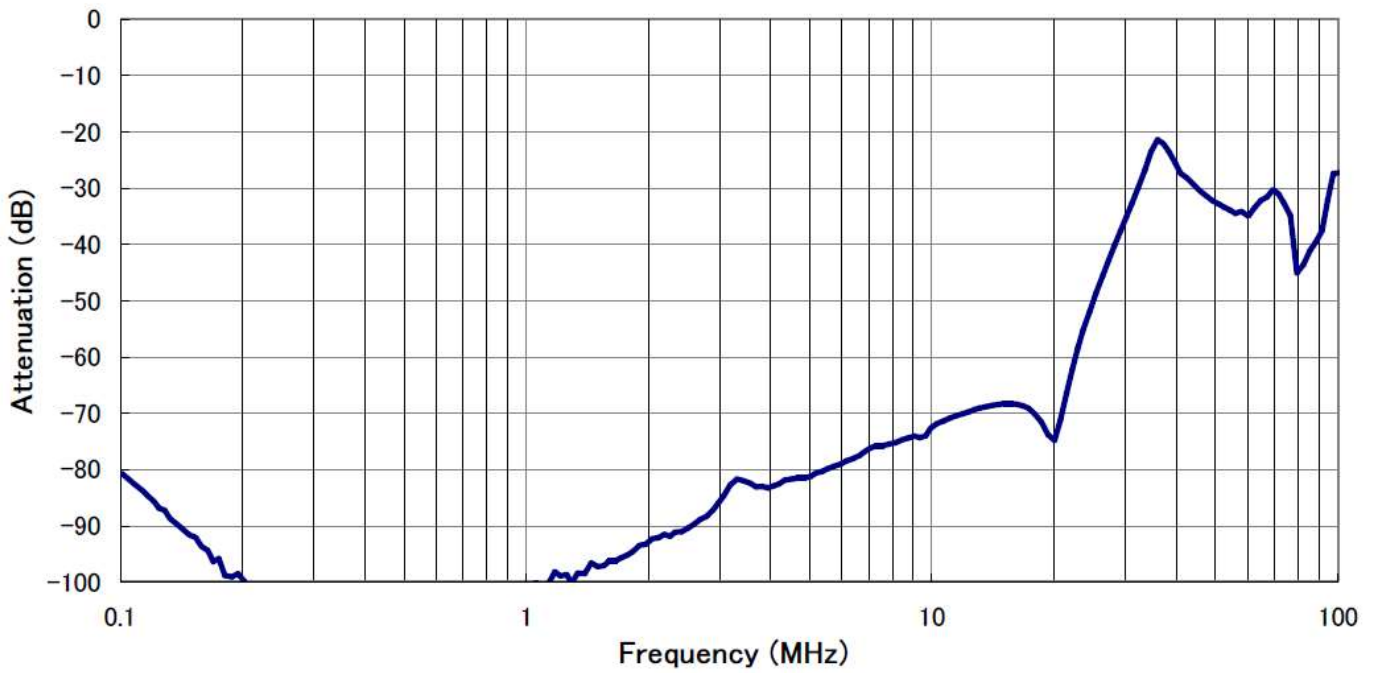

fig. 4 (200A)



代表特性 (30A)



## 代表特性 (100A)

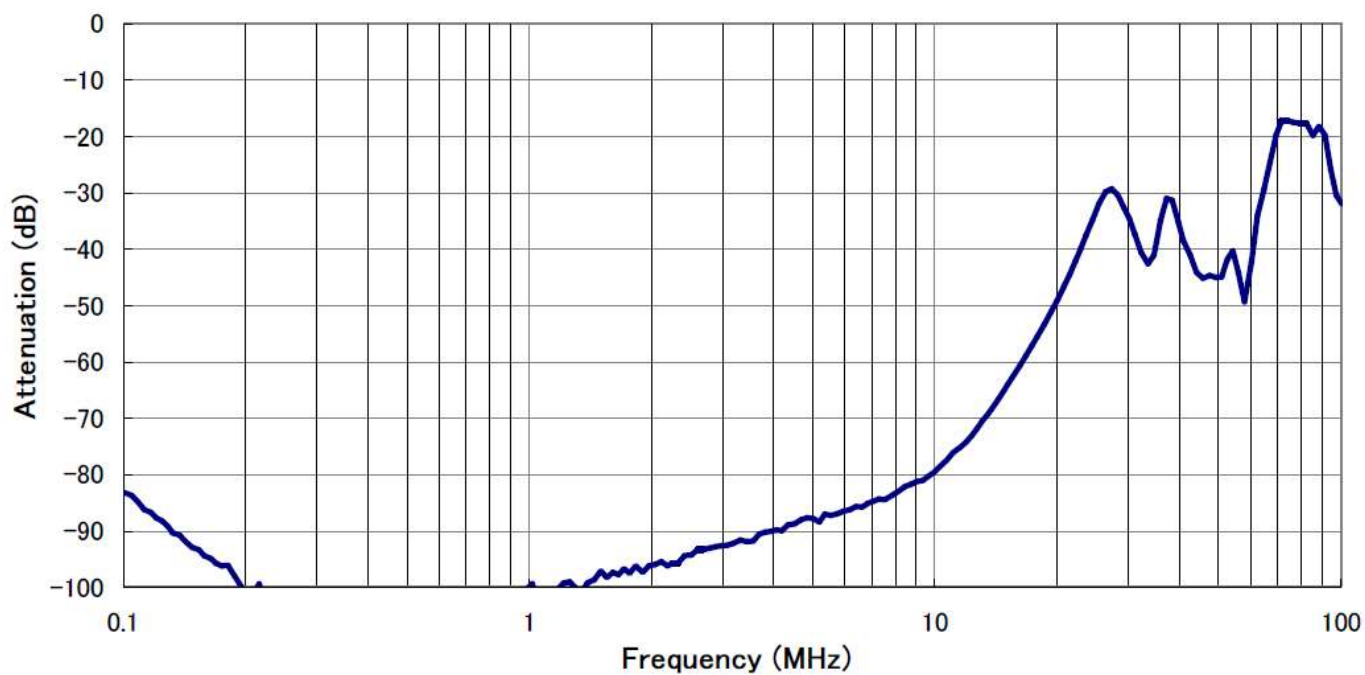

## 电路图

